



# OPERATION MANUAL

Compressed Natural Gas Fuel Module and Tank System

MSO-001 Rev05



OPERATION MANUAL FOR THE MSTAMA32-1 FUEL MODULE  
AND TANK SYSTEM

## 1.0 Purpose of this Manual

### 1.1 Introduction

This Operator/Service Manual addresses maintenance and operation of the Mainstay Fuel Technologies MSFBMA20 CNG Fuel Module and systems operations.



## 2.0 Parts and Service

Contact Mainstay Fuel Technologies to order parts, receive service information, or request assistance.

### Contact information:

[www.mainstayalt.com](http://www.mainstayalt.com)

Phone Number: (864)655-6905

Toll Free: 1-844-332-3775

### Mainstay Fuel Technologies

32 Concourse Way

Greer SC 29650



**Table of Contents**

**1.0 IMPORTANT SAFETY INFORMATION** ..... 6

**1.1 Safety Notices** ..... 7

**1.2 Precautions** ..... 8

**2.0 BASIC FUEL MODULE FUNCTIONS** ..... 9

**2.1 Fuel Control Module Components** ..... 9

**2.1.1 High Pressure Gauge** ..... 9

**2.1.2 Low Pressure Gauge** ..... 9

**2.1.3 Manual Shut Off Valve** ..... 9

**2.1.4 Purge Valve** ..... 11

**2.1.5 Fuel Filter** ..... 11

**3.0 CNG FUEL MODULE MAINTENANCE & PART REPLACEMENT** ..... 12

**3.1 Fuel Filter Location/Access Procedure** ..... 12

**3.2 O-ring Information** ..... 12

**3.3 Procedure for Draining the Fuel Filter** ..... 13

**3.4 Fuel Filter Replacement Procedure** ..... 14

**3.5 Fuel Module Receptacle O-Ring Replacement Procedure** ..... 16

**3.6 Fuel Module Receptacle Replacement Procedure** ..... 17

**3.6.1 NGV1 Receptacle Replacement Procedure** ..... 17

**3.6.2 Transit Fill Receptacle Replacement Procedure** ..... 19



---

<b>4.0 CNG FUELING PROCEDURE</b> .....	21
<b>4.1 CNG Fueling Steps</b> .....	21
<b>4.2 Types of Fueling Hoses</b> .....	22
<b>5.0 TRANSFER FUELING (REFERRED TO AS DEFUELING), OPERATING MODES, COMPONENTS, AND PROCEDURES</b> .....	26
<b>5.1 CNG Fuel Module Defueling Functions</b> .....	26
<b>5.2 CNG Fuel Module Defueling Operating Modes</b> .....	26
<b>5.3 CNG Fuel Module Defueling Components</b> .....	27
<b>5.4 Defueling Hose Description</b> .....	27
<b>5.5 CNG Fuel Module Defueling Procedure</b> .....	28
<b>6.0 BACK-OF-CAB AND SIDESADDLE OPERATIONS</b> .....	30
<b>6.1 Tank Inspection</b> .....	31
6.1.1 Preparing for Back-of-Cab CNG Storage Tank Inspection .....	31
6.1.2 Preparing for Sidesaddle CNG Storage Tank Inspection .....	33
6.1.3 CNG Storage Tank Inspection .....	34
<b>6.2 Leak Test</b> .....	35
<b>6.3 Back-of-Cab Tank Frame Inspection</b> .....	35
<b>7.0 CNG FUEL MODULE TROUBLESHOOTING</b> .....	36
<b>7.1 General Troubleshooting</b> .....	37
<b>7.2 Fuel Module Electrical Troubleshooting</b> .....	40
<b>7.2.1 CNG Fuel Module Electrical Diagnostic Tool Functions</b> .....	40
<b>7.2.2 CNG Fuel Module Electrical Diagnostic Tool Procedure</b> .....	41

---



7.2.3 Using the Mini-Tester for Fuel Module Electrical Troubleshooting .....	43
7.3 MSFBMA20 Electrical Schematic .....	46
8.0 Emergency Shutdown Procedure .....	48

## 1.0 Important Safety Information

**READ, UNDERSTAND, AND FOLLOW INSTRUCTIONS WITHIN THIS DOCUMENT BEFORE OPERATING, SERVICING, OR ADJUSTING REFERENCED EQUIPMENT.**

**ANYONE USING OR MAINTAINING THIS EQUIPMENT MUST BE FAMILIAR WITH THE PRODUCT AND FULLY TRAINED.**

**IMPROPER USAGE OR MAINTENANCE OF THIS EQUIPMENT MAY RESULT IN INJURY OR DEATH.**

Always keep a copy of this manual readily available for persons who operate the equipment or perform maintenance procedures.

Safe working procedures must be followed at all times. OSHA LOCKOUT/TAGOUT procedures must be followed when performing applicable procedures.

## 1.1 Safety Notices

Throughout this manual, safety notices are included to warn operators and maintenance technicians of the dangers associated with the described equipment operations and maintenance.

Improper operation or maintenance procedures may cause serious injury or death.

Safety notices accompany potentially hazardous situations throughout this manual. Please read and follow instructions carefully.



## 1.2 Precautions



### Danger

**NATURAL GAS IS FLAMMABLE AND EXPLOSIVE.** Never use an open flame (match, lighter, or other) to light a work area near the CNG fuel storage system.

#### Properties of Natural Gas:

Auto Ignition Point: 900 - 1170° F (482 - 632° C)

Lower Explosive Limit (%): 3.8 – 6.5

Upper Explosive Limit (%): 13 – 17



### Danger

**KEEP WORK AREA WELL VENTILATED TO AVOID ASPHYXIATION DUE TO CONCENTRATED LEVELS OF CARBON MONOXIDE.**



### Danger

**THE CNG FUEL MODULE SYSTEM CONTAINS SOME LINES THAT ARE UNDER CONTINUOUS HIGH PRESSURE. DO NOT ATTEMPT TO LOOSEN OR DISCONNECT THOSE LINES.**

## 2.0 Basic Fuel Module Functions

### Compressed Natural Gas (CNG) Fuel Module Functions

The CNG fuel tanks contain CNG at a pressure of 3,600 psi.

The CNG Fuel Module serves multiple functions within a natural gas vehicle (NGV) fuel system. These functions include:

- Storage tank refueling
- Local and remote storage tank pressure measurement
- Manual and ignition controlled fuel shut-off
- Pressure reduction from storage tank to engine supply
- Fuel system filtration
- Liquid removal from fuel system

### 2.1 Fuel Control Module Components

#### 2.1.1 High Pressure Gauge

The high pressure gauge, located in the front panel of the fuel control module, indicates the pressure of the CNG being supplied to the regulator. If the manual shut-off valve is turned to 'on' and all other valves are open between the fuel tank and the fuel control module, this gauge reflects fuel tank pressure.

#### 2.1.2 Low Pressure Gauge

Located below the high pressure gauge in the front panel of the fuel control module, the low pressure gauge indicates the pressure of the CNG leaving the regulator and supplying the vehicle's engine. A typical reading for this gauge is 100-120, depending on regulator setting.

#### 2.1.3 Manual Shut-Off Valve

The manual shut-off valve is located on the bottom front of the fuel control module. With the arrow turned up and pointing to the 'OFF' position, fuel flow from the tanks to

the vehicle's engine is prohibited. Rotate the arrow to the left to point to the 'ON' position to allow fuel flow from the tanks to the vehicle's engine.

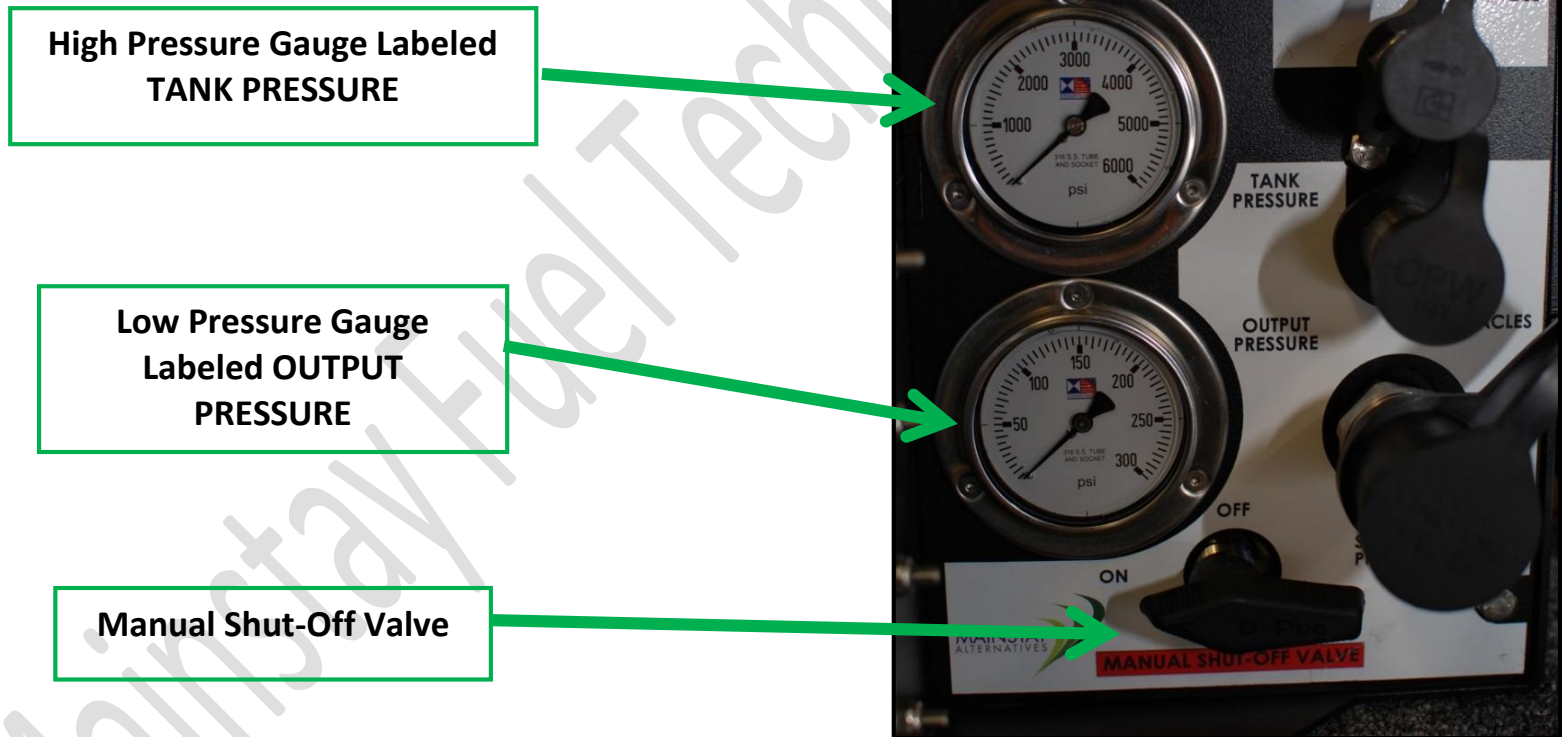

#### 2.1.4 Purge Valve

Located inside the side maintenance access door, the purge valve, when loosened, purges CNG from the vehicle's fuel control module to allow safe access to the filter assembly.

#### 2.1.5 Fuel Filter

The fuel filter is located inside the side maintenance access door. This filter collects both solid and liquid contaminants. It requires periodic maintenance.

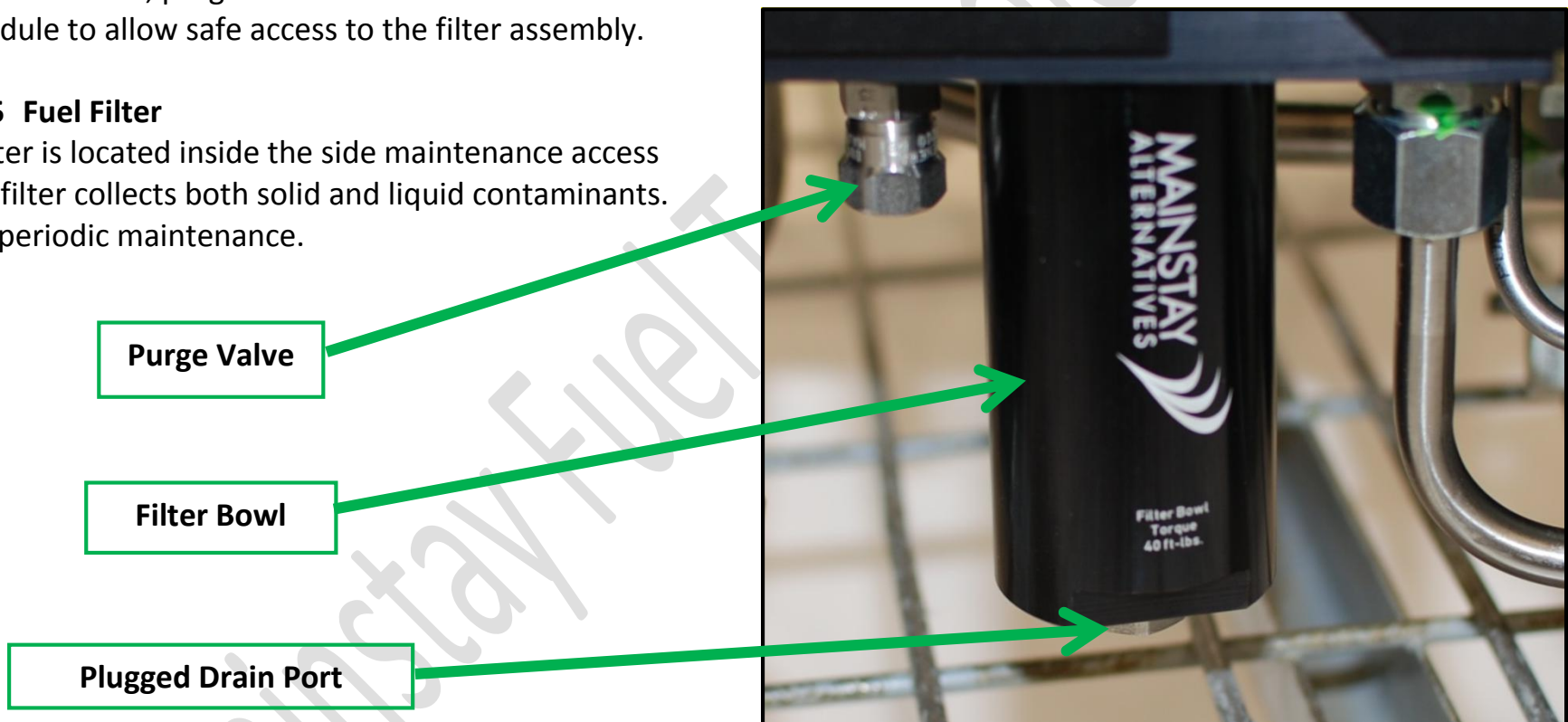

## 3.0 CNG Fuel Module Maintenance and Part Replacement

### 3.1 Fuel Filter Location / Access Procedure



#### Danger

**TO AVOID SERIOUS INJURY OR DEATH, the flow of fuel to the filter must be shut off and pressure within the filter must be relieved before servicing the fuel filter.**

1. The fuel filter is located inside the CNG module.
2. Open the side maintenance access door of the CNG module to locate the fuel filter.
3. Stop gas flow to the filter by turning the manual shut-off valve to the OFF position. **(See page 10 for location.)**

4. 2 options exist to relieve pressure in the fuel filter:
  - a) Open the purge valve. **(See page 11 for location.)**
  - b) Crank the truck and let it run until all fuel is used up and truck shuts off.
5. Check the high pressure gauge. **Make sure it is reading 0 psi before opening the fuel filter.**
6. It is now safe to remove the fuel filter.

### 3.2 O-Ring Information

The O-rings installed throughout the fuel module are Hydrogenated Nitrile (HNBR) O-rings. Recommended lubricants for use with these O-rings include:

- Super O-Lube, Parker -65 to 400
- DC-55, Dow Corning Co. -65 to 275
- Celvacene, Consolidated Vacuum Corp. -40 to 200

### 3.3 Procedure for Draining the Fuel Filter



## Danger

**BEFORE SERVICING THE FUEL FILTER, the flow of fuel to the filter must be shut off and pressure within the filter must be relieved to avoid serious injury or death. Follow steps in Section 3.1 to complete this procedure.**

#### Preventive Maintenance Schedule for the Fuel Filter:

Drain filter every 10,000 Miles

Alter the PM schedule to 5,000 Miles if high volume of oil (>10 ml) is present in filter bowl.

1. The fuel filter is located inside the CNG module.

**Locate this fuel filter following directions in Section 3.1 and picture on page 11.**

2. Be sure the manual shut-off valve has been closed and the pressure bleed valve has been opened per instructions in Section 3.1.
3. A plugged drain port is located on the bottom of the filter bowl.
4. Using a 9/16 socket or wrench, remove the plug and allow liquid to drain completely from the filter bowl.
5. Measure the amount of drainage.
6. Adjust the PM schedule if necessary, based upon amount of oil present.
7. Replace the drain plug.
8. Torque to 15 ft-lbs.
9. Close the pressure bleed valve.
10. **Slowly** turn the manual shut-off valve to the left until it reaches the **ON** position.
11. Check the high pressure gauge to confirm a rise in fuel pressure.  
NOTE: Low pressure gauge may not register pressure until vehicle ignition is turned to 'on'.

### 3.4 Fuel Filter Replacement Procedure



## Danger

**BEFORE SERVICING THE FUEL FILTER, the flow of fuel to the filter must be shut off and pressure within the filter must be relieved to avoid serious injury or death. Follow steps in Section 3.1 to complete this procedure.**

#### Filter Element Replacement Schedule:

Replace filter element after 40,000 miles or every 12 months, whichever comes first.

1. The fuel filter is located inside the CNG module.  
**Locate this fuel filter following directions in Section 3.1 and picture on page 11.**

2. Be sure the manual shut-off valve has been turned to 'OFF' and the pressure bleed valve has been opened per instructions in Section 3.1.
3. The filter bowl is threaded into the filter housing.
4. The filter housing is equipped with wrench flats to loosen for removal.
5. Loosen filter housing using the Filter Housing Removal Tool.



**Filter Housing Removal Tool  
Mainstay Fuel Technologies Part #MSSP0044**

6. Remove filter bowl.
7. Grasp filter element, pulling downward to remove.

8. If filter comes apart upon removal from filter bowl, make sure plastic end is removed from filter bowl.
9. Install new element by pressing into place until it snaps into position.



**Fuel Filter Replacement Kit  
Mainstay Fuel Technologies  
Part #MNFBM114**

10. Empty and clean filter bowl.
11. Discard old o-rings.

12. Apply lubricant to new O-rings and carefully install.
13. Place lubricant on filter housing threads.
14. Reinstall filter bowl in the filter housing and torque to 40 ft-lbs.
15. Close the pressure bleed valve.
16. **Slowly** turn the manual shut-off valve to 'ON'.
17. Check the high pressure gauge to confirm increased fuel pressure.

NOTE: Low pressure gauge may not indicate pressure until vehicle ignition is turned 'on'.



### 3.5 Fuel Module Receptacle O-Ring Replacement Procedure

The O-ring seals, located in the inlets of the 2 fueling receptacles, can wear or become damaged over time and with repeated use. If damaged, a leak may occur when fueling.

Procedure:

1. Carefully remove the worn O-ring. Avoid damaging the inner surface of the O-ring groove. Damage on the inner surface of the O-ring groove may result in a permanent leak and require replacement of the fueling receptacle.
2. Lubricate the new O-ring.
3. Install the new O-ring into the O-ring groove being careful not to damage either the new O-ring or the O-ring groove.

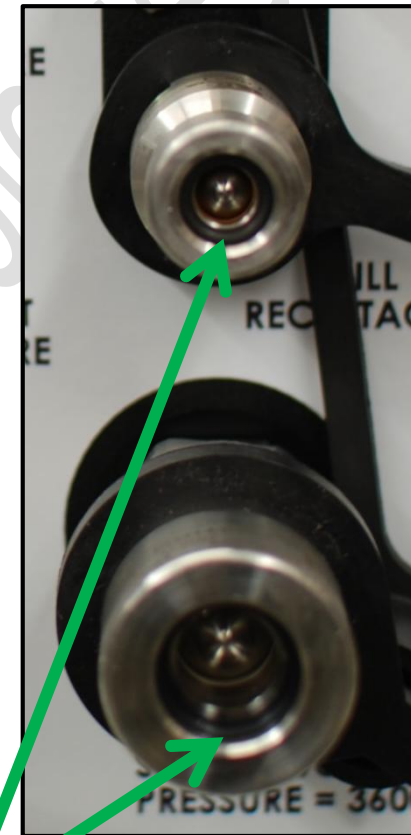

O-Rings Located Inside the 2 Fuel Receptacle Inlets

### 3.6 Fuel Module Receptacle Replacement Procedure



Both fuel receptacles are threaded into adaptors that are mounted into the manifold going through the face plate of the fuel module and are equipped with an O-ring that seals the connection.

#### 3.6.1 NGV1 Receptacle Replacement Procedure:

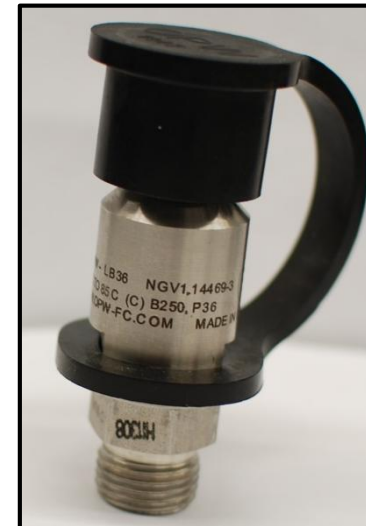

Mainstay Fuel Technologies  
Part #CP-FR-6FS-00-SH-001

1. Turn off each supply tank and run the truck until it shuts off due to lack of CNG.
2. Slide the portion of the dust cap that wraps around the fuel receptacle away from the face plate to expose the flats on the fuel receptacle.
3. Use a  $\frac{3}{4}$ " **thin profile wrench** to support flats on the adaptor fitting. Use a second  $\frac{3}{4}$ " **wrench** to loosen the receptacle from the bulkhead. A small volume of gas may escape as this connection is loosened.
4. Once loosened, allow any built-up pressure to completely escape. Remove the receptacle.
5. The old O-ring is now visible on the bulkhead fitting.
6. Remove and discard the old O-ring.
7. Lubricate a new O-ring with a small amount of lubricant.
8. Using an **O-ring torpedo**, install the new, lubricated O-ring on the bulkhead fitting. Be very careful not to cut or damage the new O-ring with the threads of the bulkhead fitting during installation of the O-ring.
9. Install the new receptacle onto the bulkhead fitting. **Torque the receptacle to 24 ft-lbs.**
10. Return the portion of the dust cap that wraps around the receptacle to its original position.
11. Return the tank valves to their original positions.

### 3.6.2 Transit Fill Receptacle Replacement Procedure:



Mainstay Fuel Technologies  
Part #CP-FR-10FS-00-SH-001

1. Turn off each supply tank and run the truck until it shuts off due to lack of CNG.
2. Slide the portion of the dust cap that wraps around the fuel receptacle away from the face plate to expose the hex of the fuel receptacle.
3. Use a **1 1/16" thin profile wrench** (often called a cylinder wrench or pump wrench) to support the flats of the adaptor fitting.
4. Use a second **1 1/4"** wrench to loosen the receptacle from the adaptor fitting. A small volume of gas may escape as this connection is loosened. **Allow pressure to bleed down completely before removing the receptacle.**

5. Locate the old O-ring which should now be visible on the adaptor fitting. Remove and discard this O-ring.
6. Lubricate a new O-ring with a small amount of O-ring lubricant.
7. Using an **O-ring torpedo**, install the new, lubricated O-ring on the adaptor fitting. Avoid any damage or cuts to the new O-ring that may occur with contact between the adaptor fitting and the O-ring.
8. Install the new receptacle onto the bulkhead fitting. Using a **1 1/16" cylinder wrench** to support the flats of the adaptor fitting, **torque the receptacle to 48 ft-lbs.**
9. Return the portion of the dust cap that wraps around the receptacle to its original position.
10. Return the tank valves to their original positions.

## 4.0 CNG Fueling Procedure



### Danger

**NATURAL GAS IS FLAMMABLE AND EXPLOSIVE. Never use an open flame (match, lighter, or other) to light a work area near the CNG fuel storage system.**

**If an emergency occurs at the fueling station, press the emergency shutdown button and call 911.**



### Danger

**DO NOT stand between the nozzle and the dispenser during fueling. Maintain a safe distance during the fueling process.**

### 4.1 CNG Fueling Steps

There are two options for filling a vehicle with CNG – timed fill or fast fill. Connecting the fueling hose is the same for either type of fill.

The steps include:

1. Locate the fueling fill receptacle in the CNG fuel module.  
**\*\*\* Please note, some fill receptacles may be installed in a remote location, either on the vehicle's front bumper or passenger side.**

2. Remove the dust cover on the fill receptacle.
3. Remove fueling nozzle from the CNG dispenser holder.
4. Begin fueling the CNG vehicle.
5. When complete, disengage the Fueling Nozzle.
6. Return the nozzle to the CNG dispenser.
7. Replace the dust cover on the receptacle.
8. Close the CNG fuel module door.

#### 4.2 Types of Fueling Hoses

Dependent upon the fueling station, different types of fueling hoses may be utilized.

##### Type 1:



When utilizing this type of nozzle, follow directions below to refuel:

1. Slide the nozzle over the receptacle intake. In order to properly engage the fill hose with the receptacle, hold the nozzle in one hand. With the free hand, twist the nozzle counterclockwise to line up the 2 arrows, facing each other. Complete the connection by pushing the fueling hose fully onto the receptacle.

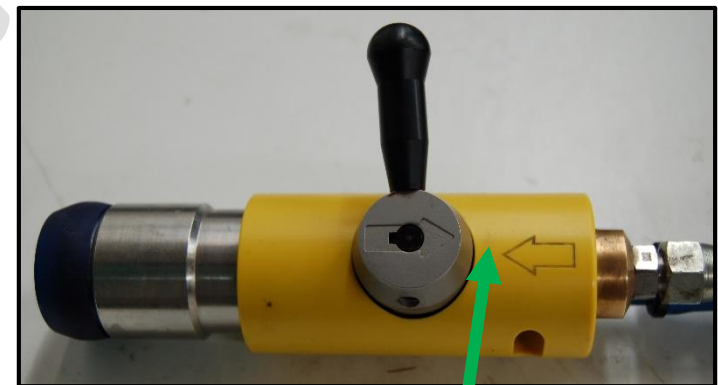

**\*\*\*NOTE: Arrows must be aligned as shown to allow proper engagement of the hose with the fill receptacle.**

2. Once the hose fits completely onto the fill receptacle, you will hear a click and the arrow on the lever will shift, misaligning with the arrow on the actual hose. This indicates that the hose fueling nozzle is properly seated onto the receptacle.
3. When the hose fully connects, turn the lever clockwise until both arrows are pointing toward the fill receptacle to begin fueling.
4. When fueling is complete, release the nozzle connection. Holding the nozzle in one hand, use the other hand to turn the nozzle so that arrows again point toward each other (as shown in step 1). You will hear a release of pressure.
5. Disconnect the fuel hose, and return it to the fuel dispenser.

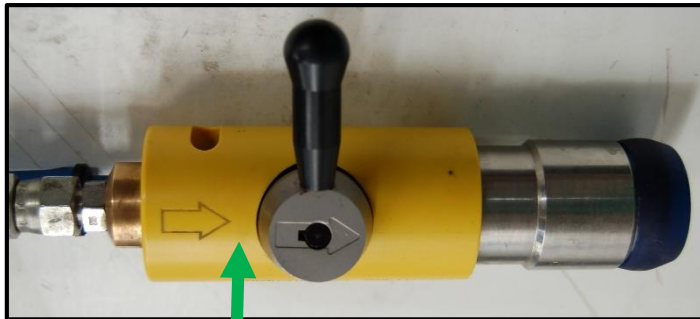

**Arrows must be aligned and pointing toward the fill receptacle to allow fueling.**



**Type 2:**



This fueling hose operates in the following manner:

- 1) Locate fill receptacle and remove dust cap.
- 2) Slide fueling hose nozzle onto the fueling receptacle.
- 3) Compress the hand grip until the locking lever engages.
- 4) Begin fueling.
- 5) When complete, release the locking lever and disconnect the fueling hose.

**Type 3:**

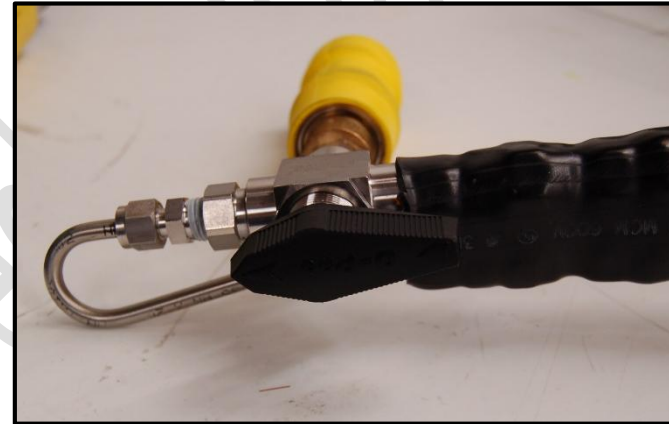

To utilize this hose:

- 1) Locate fill receptacle and remove dust cap.
- 2) Holding firmly, press nozzle onto fill receptacle.
- 3) Rotate lever clockwise 180°.
- 4) Begin fueling.
- 5) When fueling is complete, rotate lever counterclockwise 180° to allow fuel hose disconnection.

For reference purposes, the photo below details the 3 receptacles. You will connect the fueling hose at the fueling station to the proper receptacle.

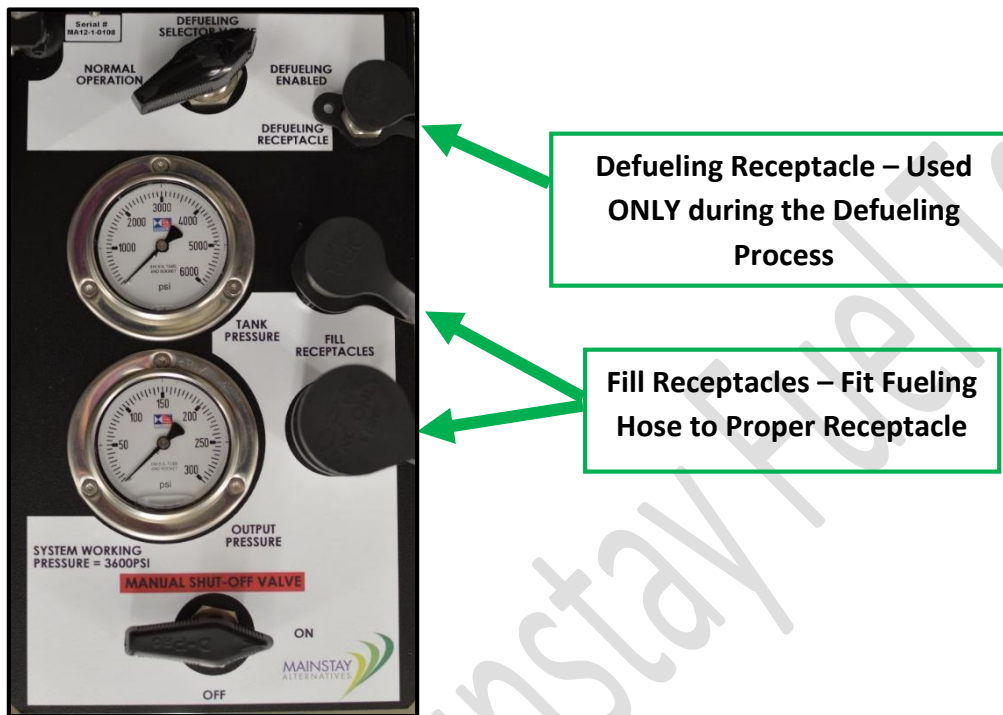

## 5.0 Transfer Fueling (Referred to as Defueling), Operating Modes, Components, and Procedures

### 5.1 CNG Fuel Module Defueling Functions

MSFBMA 20 is equipped with a defueling functionality. This allows the transfer of CNG fuel into the fill receptacle of a second CNG vehicle, using a defueling hose.

Note: The defueling process does not deplete the CNG fuel in the supplying (defueling) vehicle. The tanks of both vehicles will be pressurized with CNG fuel after the defueling process is completed. To completely deplete the CNG fuel from a vehicle, the defueling hose can be connected to a CNG fuel recovery system instead of a second vehicle.

### 5.2 CNG Fuel Module Defueling Operating Modes

When the Defueling Control Valve is positioned to the “Normal Operation Position”, as shown in picture below, the defueling receptacle is vented to the atmosphere to allow disconnection of the defueling hose.



**Fuel Module Defueling Selector Valve -  
Picture Shows Valve Set to Normal Operation**

When the Defueling Control Valve is positioned to the “Defueling Enabled” position, CNG fuel from the storage tanks can flow to the Defueling Receptacle.

### 5.3 CNG Fuel Module Defueling Components

Defueling components are located on the front panel of the fuel module. The components include:

Defueling Receptacle – connection point for transferring CNG fuel out of the fuel system

Defueling Selector Valve – facilitates CNG fuel transfer



### 5.4 Defueling Hose Description

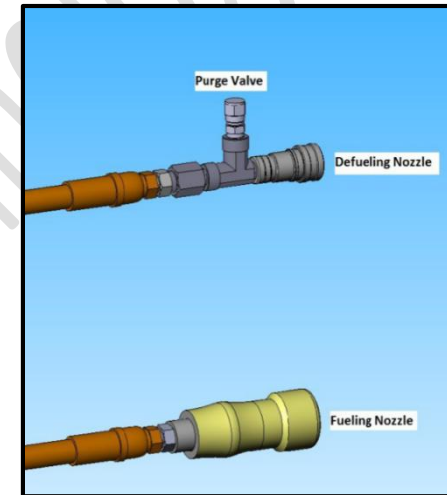

The Defueling Hose is Part #MSDFM002, equipped with a quick-connect on both the Fueling and Defueling ends.

1. The Defueling Hose (if available) is to be used for the purpose of transferring CNG fuel from a supplying (defueling) vehicle to a receiving (fueling) vehicle.
  2. The tank pressure of the supplying vehicle must be higher than the tank pressure of the receiving vehicle in order for CNG fuel to transfer.
  3. Once the two (2) vehicles' tank pressures have equalized due to the transfer of CNG fuel, no further transfer of CNG fuel will occur.
  4. In order to use the Defueling Hose, the vehicle being defueled must be equipped with a defueling receptacle.
  5. If the vehicle is not equipped with a defueling receptacle, then the defueling operation is not possible using the Defueling Hose Assembly.
- 5.5 CNG Fuel Module Defueling Procedure**
1. Prior to connecting the defueling hose to either vehicle, open the purge valve on the hose to release any residual pressure that may be in the hose.
  2. Close the purge valve and continue.
  3. Position the defueling control valve on the MSFBMA 20 fuel module in the "Normal Operation" position. This will release any pressure in the defueling circuit and allow the hose's defueling nozzle to be connected to the defueling receptacle.
  4. If the valve is not in this position, it will not be possible to make the connection.
  5. Connect the hose's defueling nozzle to the defueling receptacle in the MSFMA 20 module of the supplying (defueling) vehicle.
  6. Connect the hose's fueling nozzle to the NGV1 fueling receptacle on the receiving (fueling) vehicle.
  7. Turn the defueling control valve on the supplying (defueling) vehicle to "Defueling Enabled". This will initiate the flow of CNG fuel from the supplying vehicle to the receiving vehicle.

8. To stop the flow of CNG fuel, turn the Defueling Control Valve to the “Normal Operation” position. This will stop the flow of CNG fuel and vent the pressure in the defueling hose so that it can be disconnected. If the supplying vehicle is not equipped with a defueling control valve which automatically vents the pressure in the hose when the flow of CNG fuel is stopped, then the purge valve must be used to vent the hose and allow disconnection of the hose from the defueling receptacle.

## 6.0 Back-of-Cab and Sidesaddle Operations

This section addresses two distinct locations. The first is the area directly behind the cab of the truck, called the Back-of-Cab area. The second location is referred to as the Sidesaddle. This area is located on the passenger side of the cab, directly below the step rail and behind the fairing.

The Back-of-Cab area contains 5 high pressure CNG storage tanks. Each storage tank is equipped with a manual shut-off valve. (Reference the diagram for the location of each).

The Sidesaddle contains 1 high pressure CNG storage tank, which is also equipped with a manual shut-off valve. (Reference the diagram for the location).

It is important to note that one of the lines exiting the valve (indicated as red/yellow in the diagram) go to the Pressure Relief Device. This line is ALWAYS pressurized to the tank pressure and is marked with a sticker colored red/yellow.

**NEVER attempt to disconnect or loosen the fittings on the high pressure lines.**

Generally, the valves on the tanks remain in the OPEN position unless an emergency situation develops. Refer to section **8.0 Emergency Shutdown Procedure** for additional information.

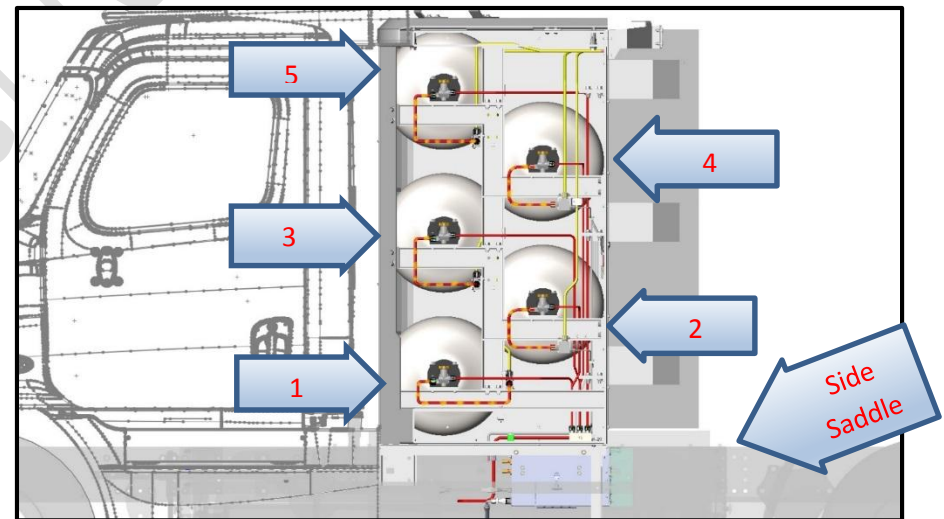

## 6.1 Tank Inspection

Periodically, the CNG storage tanks need to be inspected to check for damage or wear. Inspections should occur at intervals of 3 years or 36,000 miles, whichever comes first.

### 6.1.1 Preparing for Back-of-Cab CNG Storage Tank Inspection

In order to properly view the tanks, several areas of the truck's exterior panels must be removed.

Standing behind the back-of-cab CNG storage tank unit, follow the steps below for access to the CNG storage tanks:

1. Completely remove the silver handrail behind the driver's side fairing.
2. Completely remove the hose suspension bar located at the top of the CNG tank storage unit.
3. Remove the hose bracket located on the driver's side back-of-cab panel.

4. Remove bolts holding the 2 back panels in place.
5. Loosen the bolts of the airflow deflector bracket located on top of the passenger side back-of-cab panel.
6. Starting on the passenger side, pull the panel out and lower it only enough to reach the light's electrical connection. Reach in and disconnect the connector. Remove panel.
7. Repeat step 6 for the driver's side panel.
8. Perform tank inspection as outlined in Section 6.1.3.
9. Reassemble the unit when inspection is complete.



Back-of-Cab Area



Airflow  
Deflector  
Bracket  
(Driver's Side)

Hose Suspension  
Bar

Silver Handrail

Bracket

Airflow Deflector  
Bracket (Passenger  
Side)

### 6.1.2 Preparing for Sidesaddle CNG Storage Tank Inspection

1. Remove 4 hidden/recessed bolts on the step fairing of the passenger side. Dislodge and remove step fairing.
2. Located behind the wing fairing, the top of the CNG storage tank is covered for protection. Loosen the 5 bolts securing this covering and remove.
3. Perform tank inspection as outlined in Section 6.1.3.
4. Reassemble the unit when inspection is complete.

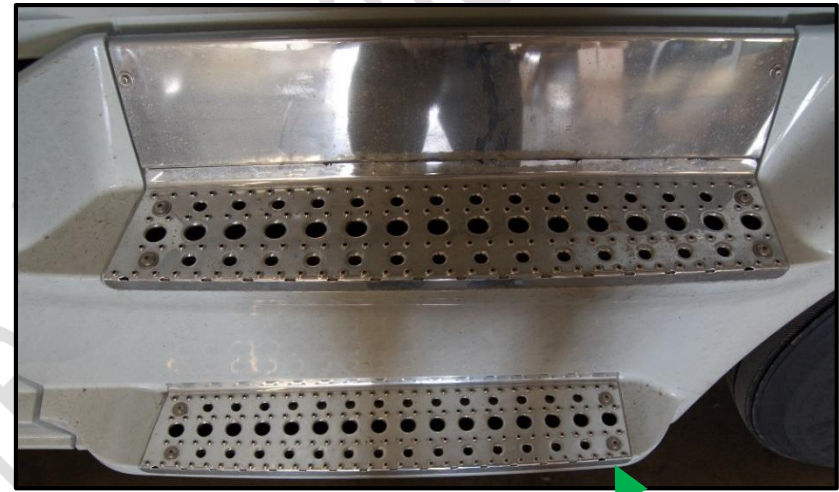

Step Side Fairing

Blow-Up of Step Grid  
Showing Recessed Bolt

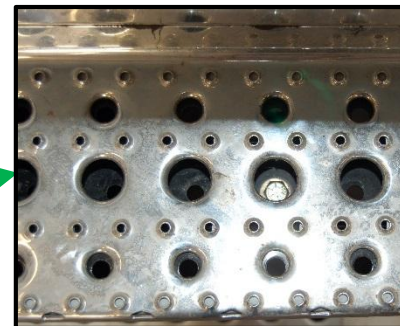

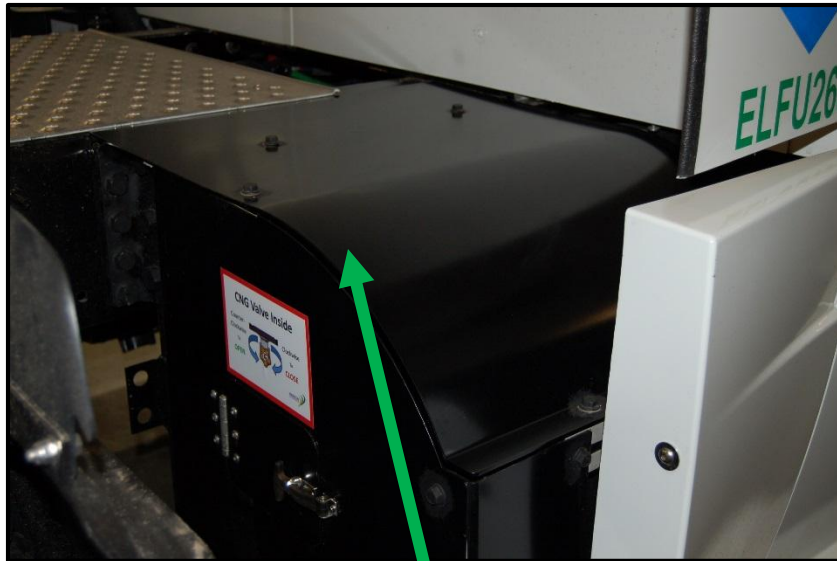

Located Behind the Passenger Side Fairing,  
Remove the 5 Bolts on this CNG Storage Tank  
Cover to expose the CNG Tank for Inspection

### 6.1.3 CNG Storage Tank Inspection

Reference the tank manufacturer's manual or website for complete details on the tank inspection procedure.

## 6.2 Leak Test

### Perform the Leak Test on a Monthly Basis Use a Methane Detector or Leak Detection Solution

When performing the Leak Detection Test, the CNG tanks should be full. Leak test the entire fuel system, checking all connection points.

If a leak is detected, depressurize the system, re-pressurize to tank pressure, and retest. If the leak is again detected, take the necessary steps to repair the leak before operations are resumed.

## 6.3 Back-of-Cab Tank Frame Inspection

As part of the preventive maintenance on the back-of-cab assembly, check torque on all mounting hardware. Refer to torque chart for specifications.

Size	Recommended Torque											
	Grade 2		Grade 5		Grade 8		18-8 S/S		Bronze		Brass	
	Coarse	Fine	Coarse	Fine	Coarse	Fine	Coarse	Fine	Coarse	Fine	Coarse	Fine
#4*	-	-	-	-	-	-	5.2	-	4.8	-	4.3	-
#6*	-	-	-	-	-	-	9.6	-	8.9	-	7.9	-
#8*	-	-	-	-	-	-	19.8	-	18.4	-	16.2	-
#10*	-	-	-	-	-	-	22.8	31.7	21.2	29.3	18.6	25.9
1/4	4	4.7	6.3	7.3	9	10	6.3	7.8	5.7	7.3	5.1	6.4
5/16	8	9	13	14	18	20	11	11.8	10.3	10.9	8.9	9.7
3/8	15	17	23	26	33	37	20	22	18	20	16	18
7/16	24	27	37	41	52	58	31	33	29	31	26	27
1/2	37	41	57	64	80	90	43	45	40	42	35	37
9/16	53	59	82	91	115	129	57	63	53	58	47	51
5/8	73	83	112	128	159	180	93	104	86	96	76	85
3/4	125	138	200	223	282	315	128	124	104	102	118	115
7/8	129	144	322	355	454	501	194	193	178	178	159	158
1†	188	210	483	541	682	764	287	289	265	240	235	212

\* Sizes from 4 to 10 are in lb-in.  
 Sizes from 1/4 up are in lb-ft.  
 † Fine thread figures are for 1-14.  
 Grade 2, 5, and 8 values are for plated bolts.

## 7.0 CNG Fuel Module Troubleshooting

Please provide the following information when calling 1-844-332-3775 with troubleshooting questions or problems:

Serial # of Fuel Module

Truck #

Details of:

When the problem started

What the problem entails

Any troubleshooting performed

Results of troubleshooting actions

### 7.1 General Troubleshooting without a Mini-Tester

The following table lists possible problems, along with causes, corrections, and results. Refer to Section 7.2 for instructions on Troubleshooting with a Mini-Tester.

Problem Observed	Possible Causes	Corrective/Diagnostic Actions	Results and other actions
Vehicle's starter will not operate.	Interrupt door switch signal is not being properly recognized by the vehicle.	<p>Close the CNG fuel module door.</p> <p>Disconnect the 12-pin electrical connector at the rear of the fuel module.</p> <p>Use an ohm meter or continuity tester across pins 9 (GRN) &amp; 10 (YEL) of the fuel module side of the connector (female connector).</p> <p>Press and release the fuel module's interrupt door switch. When the switch is depressed, there should be continuity between pins 9 (GRN) &amp; 10 (YEL). Continuity should be lost when the switch is released.</p>	<p>If operation of the door switch makes and breaks continuity as described, and the starter will not operate, there is most likely a problem in the vehicle's wiring.</p> <p>If operation of the door switch does NOT make and break continuity as described, there is most likely a wiring problem in the fuel module.</p> <p>If the problem cannot be resolved, call <b>1-844-332-3775</b> for technical assistance.</p>

Problem Observed	Possible Causes	Corrective / Diagnostic Actions	Results and Other Actions
<p>Vehicle's starter operates but the vehicle does not run.</p>	<p>Fuel is not making it through the fuel module to the engine.</p>	<p>*The manual valve on the front of the fuel module should be set to "On".</p> <p>*The fuel module high pressure gauge should read above 500 psi. Disconnect the 12-pin electrical connector at the rear of the fuel module. Use a DC voltmeter across pins 8(BLU) &amp; 9(GRN) of the vehicle side of the connector (male connector). The voltage should read:</p> <p>Ignition switch 'off' 0 vdc            Ignition switch 'run' 12 vdc            Ignition switch 'start' 12 vdc</p> <p>*Reconnect the 12-pin electrical connector at the rear of the fuel module. Have an assistant repeatedly cycle the ignition switch between 'off' and 'run' while listening for the "click" of the fuel solenoid being actuated near the maintenance door.</p>	<p>*If the voltage does NOT change as described, the problem is most likely located in the vehicle's electrical signal that actuates the fuel solenoid.</p> <p>*If the voltage changes as described and the "click" of the fuel solenoid is detected, the problem is most likely an engine control problem prohibiting the vehicle from starting.</p> <p>*If the voltage changes as described but the "click" of the fuel solenoid is NOT detected then the problem is most likely a failed solenoid in the fuel module.</p> <p>*If the problem cannot be resolved, call <b>1-844-332-3775</b> for technical assistance.</p>

Problem Observed	Possible Causes	Corrective / Diagnostic Actions	Results and Other Actions
<p>In-cab fuel gauge does not indicate the fuel level correctly.</p>	<p>The fuel module pressure transducer, the fuel gauge or the interconnecting wiring may be defective.</p>	<p>Confirm that the 12-pin electrical connector at the rear of the fuel module is connected and place the vehicle's ignition switch in the 'run' position. Use a voltmeter to read:</p> <ul style="list-style-type: none"> <li>• Voltage between connector positions 2(RED) &amp; 3(BLK). The voltage should be 12 vdc.</li> <li>• Voltage between connector positions 3(BLK) &amp; 4(WHT). The voltage should be between 0.5 to 5.0 vdc.</li> </ul>	<p>*If the voltage across 2 &amp; 3 is 0 or is significantly below battery voltage, the problem is with the vehicle's wiring. It is not supplying power to the fuel module's pressure transducer.            *If the voltage across 3 &amp; 4 is either 0 or 5.5 vdc, the fuel module's pressure transducer is most likely defective. Call <b>1-844-332-3775</b> for technical assistance.            *If the voltage across 3 &amp; 4 is between 0.5 to 5.0 vdc the fuel module's pressure transducer is operating correctly. The problem is likely in the vehicle's wiring or the in-cab fuel gauge.            *If the problem cannot be resolved, call <b>1-844-332-3775</b> for technical assistance</p>



## 7.2. Fuel Module Electrical Troubleshooting with a Mini-Tester

### 7.2.1 CNG Fuel Module Electrical Diagnostic Tool Functions

The Fuel Module Mini-Tester is designed to allow manual control of CNG fuel module functions, independent of the vehicle's electrical system. The Mini-Tester's internal power supply provides power to the pressure transducer and the fuel solenoid. Outputs generated by the fuel module, such as the pressure transducer signal and module door interrupt, are passed to the vehicle so the vehicle's engine can be started while the Mini-Tester is connected.

The purpose of the Mini-Tester is to diagnose any fuel system-related electrical problems while the system is fully intact. It allows the user to have manual control of the fuel solenoid, displays the status of the module door interrupt, and shows the voltage output of the pressure transducer.

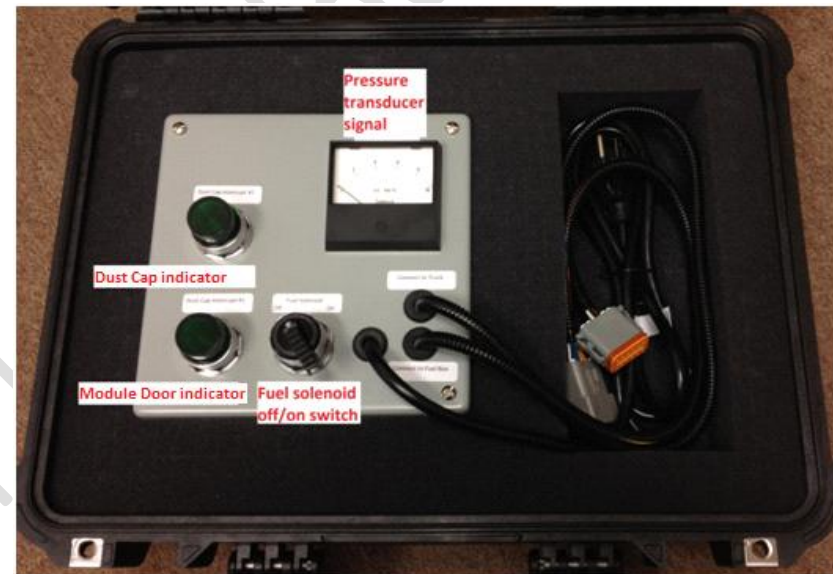

**Fuel Module Mini-Tester**  
**Mainstay Fuel Technologies Part #MSTEMA02**

## 7.2.2 CNG Fuel Module Electrical Diagnostic Tool Procedure

### Connecting the Mini-Tester:

1. Turn the vehicle's ignition to the "Off" position.
2. At the rear of the fuel module, disconnect the electrical connector which connects the fuel module to the vehicle's wiring harness.
3. Plug the Mini-Tester's "Connect to Fuel Module" lead into the fuel module electrical connector.
4. Plug the Mini-Tester's "Connect to Truck" lead into the vehicle's wiring harness.
5. Plug the Mini-Tester's power cord into a 110 VAC outlet.
6. After the above connections have been made, the vehicle's ignition switch can be used in the normal manner.
7. To disconnect the Mini-Tester, turn the vehicle's ignition to the "Off" position and reconnect the fuel module to the vehicle's wiring harness.

### Operation of the Mini-Tester:

1. The "Module Door Indicator" will illuminate when the module door is closed. Most fuel modules are equipped with a module door interrupt. The module door interrupt is used to inhibit the vehicle's starter circuit so the vehicle cannot be started if the module door is open, minimizing the potential for the vehicle to be driven with a fueling hose connected.
2. Some fuel modules may also be equipped with an interrupt dust cap. If this is the case, the "Dust Cap Indicator" will illuminate when the fuel module's dust cap is in place on the receptacle. If equipped, this dust cap must also be in place before the vehicle may be started.
3. The "Fuel Solenoid Off/On" switch allows manual control of this solenoid valve. As the switch is cycled, an audible click should be heard from inside

the fuel module as the solenoid valve opens and closes. With the Mini-Tester connected to the vehicle, this switch must be in the “On” position in order for the vehicle to be started.

4. The pressure transducer output is displayed on the meter at the top of the Mini-Tester. The pressure transducer signal will range from 0.5 vdc to 4.5 vdc as the vehicle’s CNG tank pressure ranges from 0 psi to 3600 psi. The signal from the transducer is used by the in-cab fuel gauge to display the fuel level.

### 7.2.3 Using the Mini-Tester for Fuel Module Electrical Troubleshooting

Problem Observed Prior to Connecting the Mini-Tester	Possible Causes	Corrective/Diagnostic Actions (with Mini-Tester connected)	Results and Other Actions
Vehicle's starter will not operate.	Interrupt signals are not being properly recognized by the vehicle.	<p>Place the interrupt dust cap (if equipped) on the receptacle and confirm that the "Dust Cap Indicator" is lit.</p> <p>Close the module door and confirm that the "Module Door Indicator" is lit.</p>	<p>*If these corrective actions do not cause their respective indicators to light, a wiring problem most likely exists within the fuel module.</p> <p>*If all indicators light and the vehicle will not start, the problem is most likely located within the vehicle's wiring.</p> <p>*If the problem cannot be resolved, call <b>1-844-332-3775</b> for technical assistance.</p>

Problem Observed Prior to Connecting the Mini-Tester	Possible Causes	Corrective/Diagnostic Actions (With Mini-Tester Connected)	Results and other actions
Vehicle's starter operates but the vehicle does not run.	Fuel is not making it through the fuel module to the engine.	<ul style="list-style-type: none"> <li>*The manual valve on the front of the fuel module should be set to "On".</li> <li>*The fuel module high pressure gauge should read above 500 psi.</li> <li>*Cycle the Mini-Tester "Solenoid Off/On" switch several times. Listen for the "click" of the fuel solenoid being actuated inside the fuel module.</li> <li>*Set the Mini-Tester "Solenoid Off/On" switch to "On" and try to start the vehicle.</li> </ul>	<ul style="list-style-type: none"> <li>*If the "click" of the solenoid is <b>not</b> detected, the problem is most likely a wiring problem in the fuel module.</li> <li>*If the "click" is detected and the vehicle runs with the Mini-Tester connected, the problem is most likely located in the vehicle's signal that actuates the fuel solenoid.</li> <li>*If the problem cannot be resolved, call <b>1-844-332-3775</b> for technical assistance.</li> </ul>

Problem Observed Prior to Connecting the Mini-Tester	Possible Causes	Corrective/Diagnostic Actions (with Mini-Tester Connected)	Results and Other Actions
In-cab fuel gauge does not indicate the fuel level correctly.	The fuel module pressure transducer, the fuel gauge, or the interconnecting wiring may be defective.	Observe the “Pressure Sensor Output” displayed on the Mini-Tester.	<p>*If the “Pressure Sensor Output” is either 0 vdc or 5.5 vdc, the pressure transducer is most likely defective.</p> <p>*If the “Pressure Sensor Output” is between 0.5 vdc and 5.0 vdc, the pressure transducer is operating correctly. The problem likely lies within the interconnect wiring or the in-cab fuel gauge.</p> <p>*If the problem cannot be resolved, call <b>1-844-332-3775</b> for technical assistance.</p>

### 7.3 MSFBMA20 Electrical Schematic

The MSFBMA20 electrical schematic with the signal conditioner is included on the following page.

Reference the schematic when troubleshooting the fuel module's electrical system.

### Wiring Diagram with Signal Conditioner

REV. NO.	DESCRIPTION	ECO NO.	MADE BY	CHK'D BY	DATE
-	SEE SHEET 1	-	-	-	-

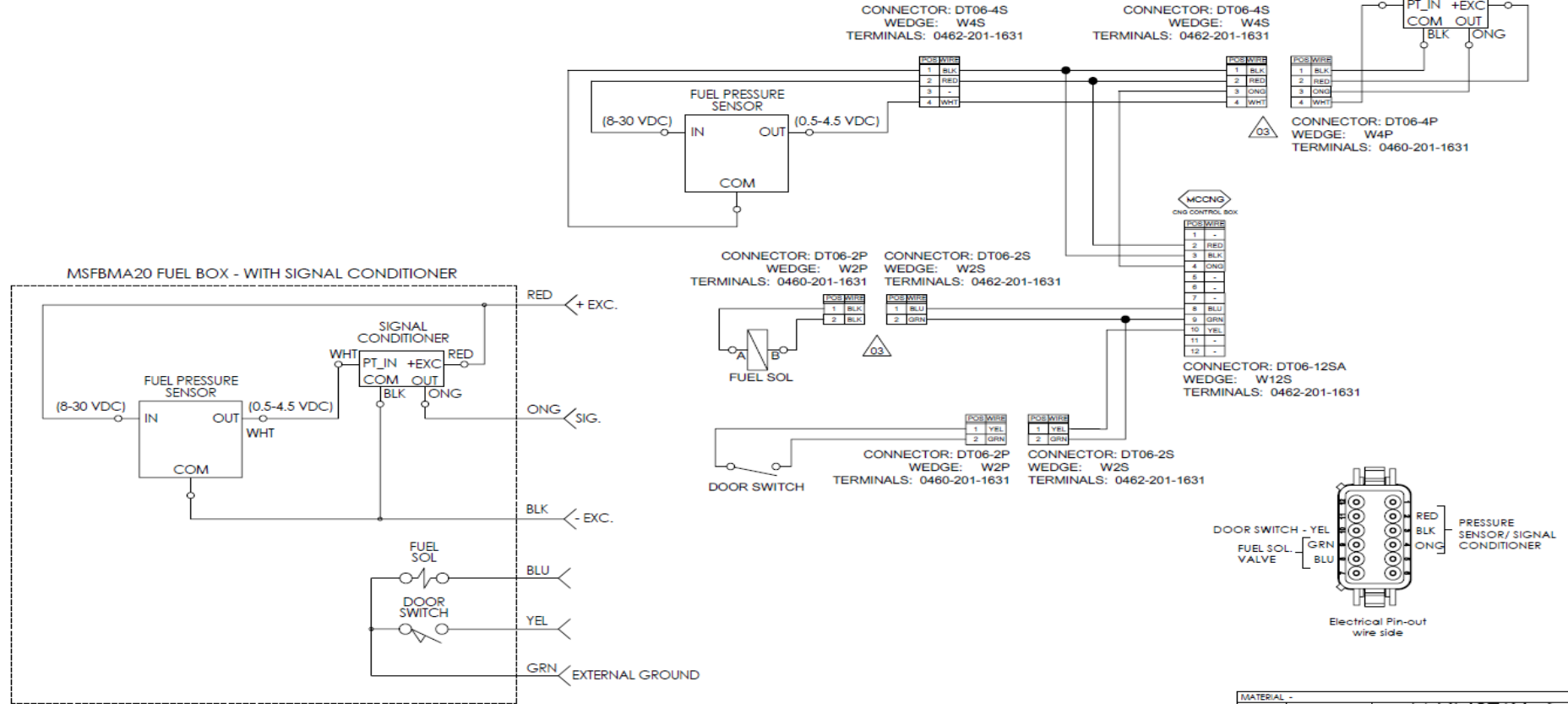

Note:

SCALE: 1:1

CONFIDENTIAL

MATERIAL	-	MADE FROM	-	
PROJ. ID	-	DATE	1/17/2011	
TITLE Electrical Schematic - w/ Signal Conditioner CNG Fuel Box - MSFBMA20				Sheet 3 of 3
ENGINEER	S. M. McDonald	REV.	03	DRAWING NO.
DRAFTER	-	Configuration	- With Signal Conditioner	MSFB2012-3
NEXT ASSY.	QTY	Print Date:	1/14/2014	

File Name - MSFB2012\_Electrical Schematic



## 8.0 Emergency Shutdown Procedure

In an emergency situation, complete the following steps to shut down the CNG system.

1. Turn OFF Ignition & Electrical System.
2. Turn OFF Fuel Module Manual Shut Off Valve.

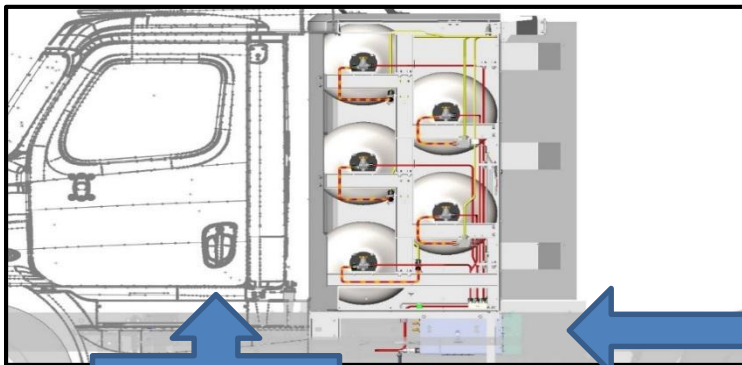

In Cab Electrical  
OFF Switch

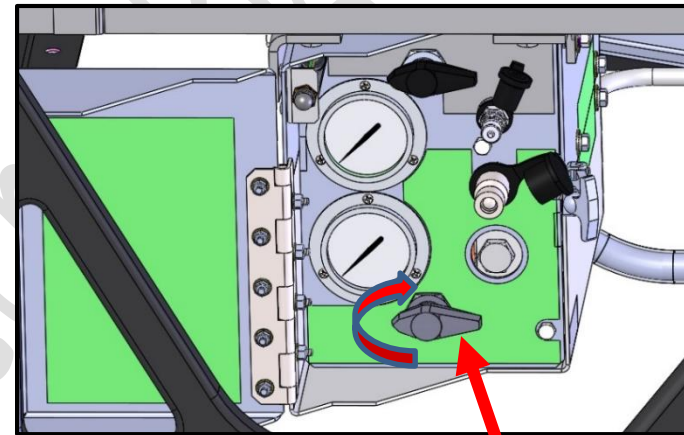

Manual Shut-Off  
Valve

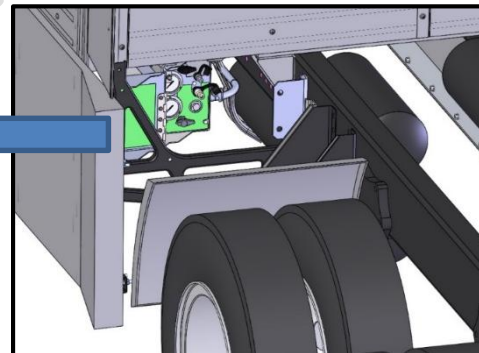

3. Turn OFF each Tank valve – 5 Main Tanks & 1 Side Saddle Tank (if installed).
4. Call 1-844-332-3775 for further assistance.

